

Please read the instructions carefully before installing the product.





# IOBOX - Installation Manual

## B1-005

# Inhaltsverzeichnis

General Installation Instructions..... 3  
 Connection Channel A – Intake Manifold Pressure Sensor..... 6  
 Connection Channel B – Boost Pressure Sensor..... 7  
 Connection Channel C – Camshaft Sensor..... 8  
 Completing the Installation..... 9  
 Support-Contact Information..... 10  
 Imprint..... 11

## Explanation of Symbols

-  Information
-  Important Notes
-  Tips und Tricks

## General Installation Instructions

1. **Warranty Protection and Long-Term Satisfaction:** Follow the instructions carefully to avoid premature warranty loss and to enjoy long-term satisfaction with your performance-enhancing product.
2. **Safety Measures Before Installation:** Install the system only with the ignition turned off, and keep the ignition key out of the vehicle's reach. Allow the engine to fully cool down before installation to avoid burns from hot engine components.
3. **Waiting Time After Turning Off the Ignition and Handling Keyless Go & Keyless Entry:** After turning off the ignition, wait at least about 5 minutes to ensure all electrical consumers in the vehicle/engine compartment are completely shut down. For vehicles with Keyless-Go or Keyless Entry systems, keep the vehicle key out of the vehicle's reach to ensure the engine management system is completely shut down. This prevents accidental damage to the electronics during installation or the occurrence of errors in the engine management system.
4. **Optimal Placement and Attachment of the Module and Cable Adapter:** Install the module in a dry location in the engine compartment.
  - **Avoiding Heat Sources:** Do not install the module near hot engine parts such as the engine block or moving parts. High temperatures can shorten the lifespan of electronic components and damage plastic parts.
  - **Secure Cable Routing:** Ensure the wiring harness does not rub against moving or sharp parts. Avoid any modifications to the wiring harness such as extensions or shortenings, as this could impair functionality and void the warranty.
  - Do not route the cable along the spark plugs or fuel injectors to prevent interference.
5. **Caution During Engine Cleaning:** Avoid directing the water jet directly at the installed system. Maintain a safe distance to prevent water damage.

# Installation of the IOBOX Cable Adapter and Module

First remove the motor cover.



Make sure you connect the correct sensors. Follow the instructions in this manual exactly. The wiring harness and the positioning of the module can be flexible as long as you observe the following points:

- Do not lay the wiring harness parallel to ignition or injector lines, hot parts of the exhaust tract or moving parts such as in the area of the belt drive or cooling system (fan).
- Use the cable ties supplied to secure the wiring harness and the IOBOX module. Ensure that all fastenings are secure and tight to prevent chafing or slipping.



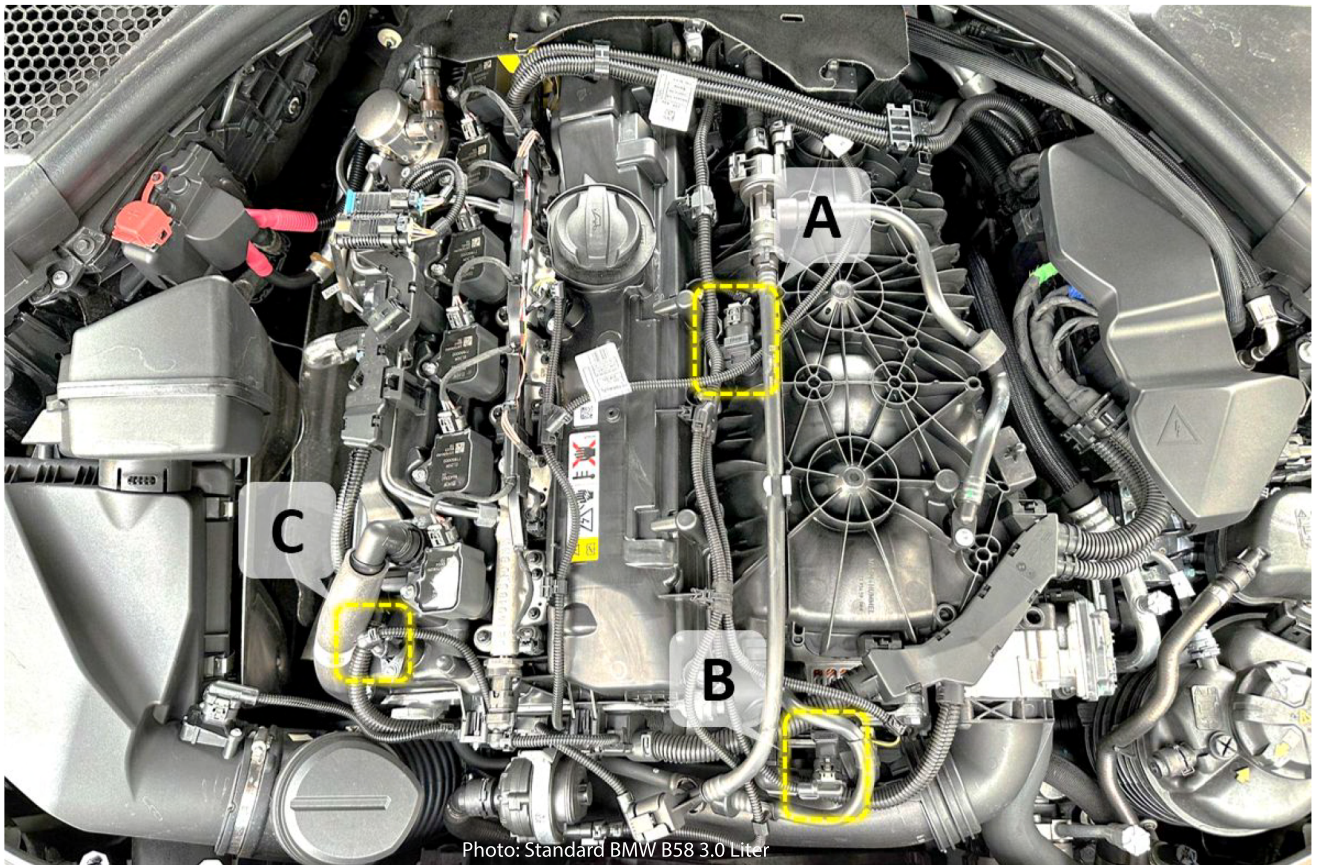

The pressure sensors A and B as well as the camshaft sensor C are easy to reach on this engine type. See illustration.

All three connectors are of the same type. Before the connectors can be disconnected, the fuses must first be unlocked. See the following description.



## Connection Channel A – Intake Manifold Pressure Sensor

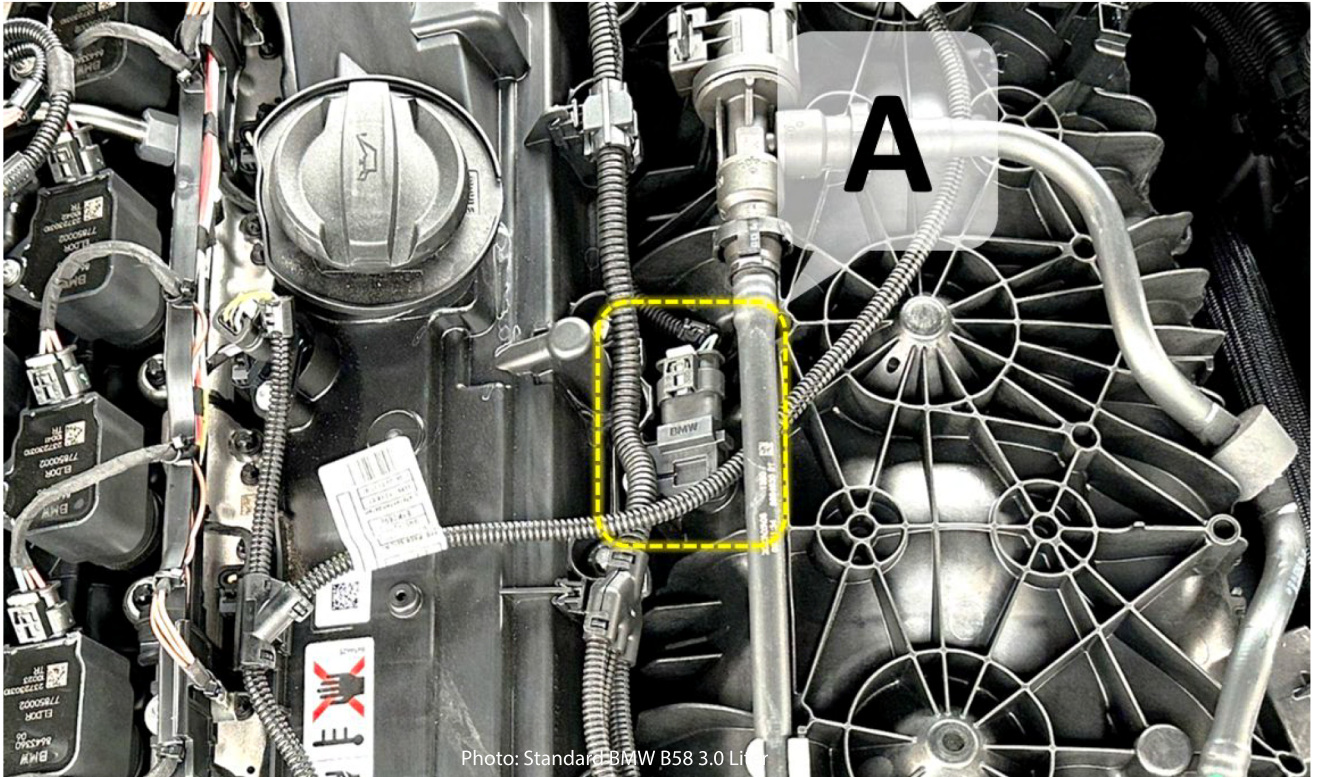

### Connecting the Plug A



#### 1. open the plug connection:

To open the plug connection on the pressure sensor (A), first unlock the gray lock - in the direction of the arrows. Then press the open lock downwards until the plug connection can be released.

#### 2. connect channel A:

Connect the connection channel A of the supplied cable between the sensor and the connector of the vehicle. Ensure that the connection engages firmly and securely in the correct orientation.

#### 3. lock the locking mechanism:

Then lock the gray locking pins of the connectors again to ensure that the connection is stable and secure.



## Connection Channel B – Boost Pressure Sensor

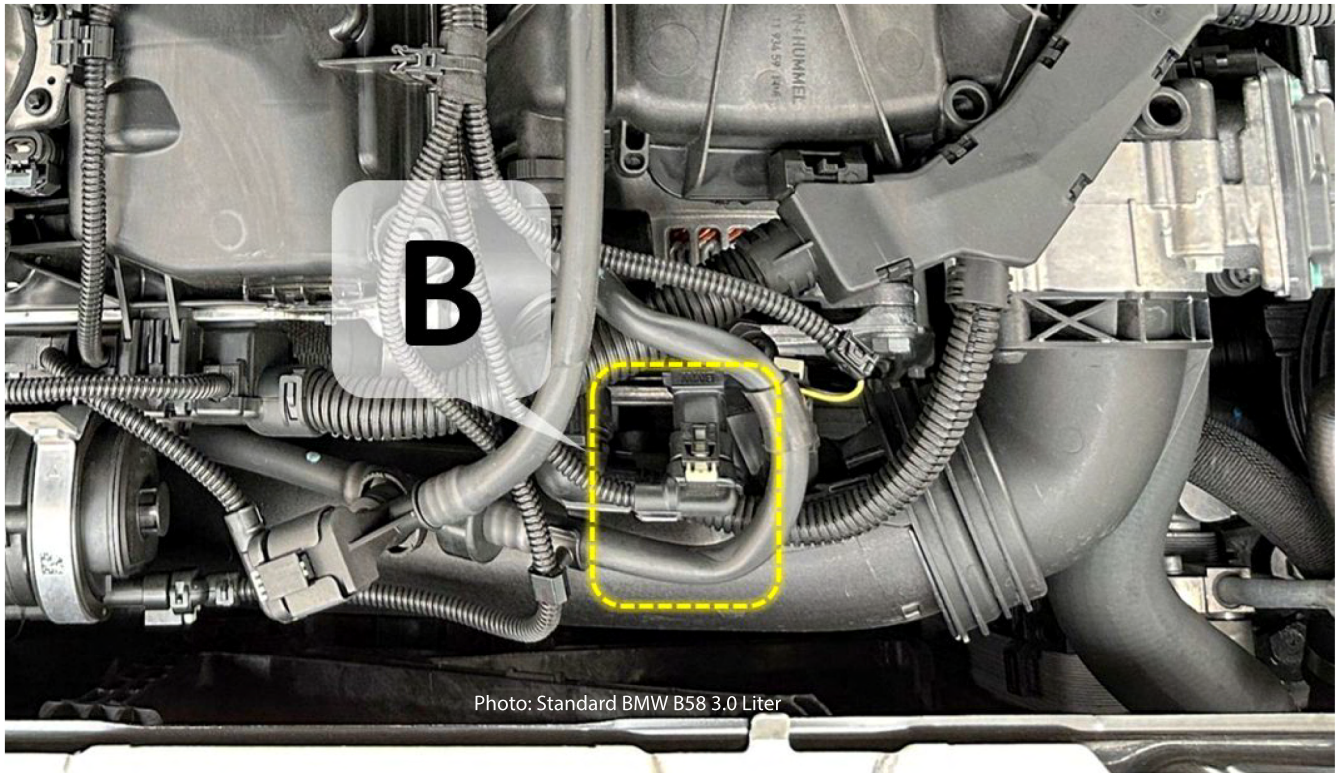

### Connecting the Plug B

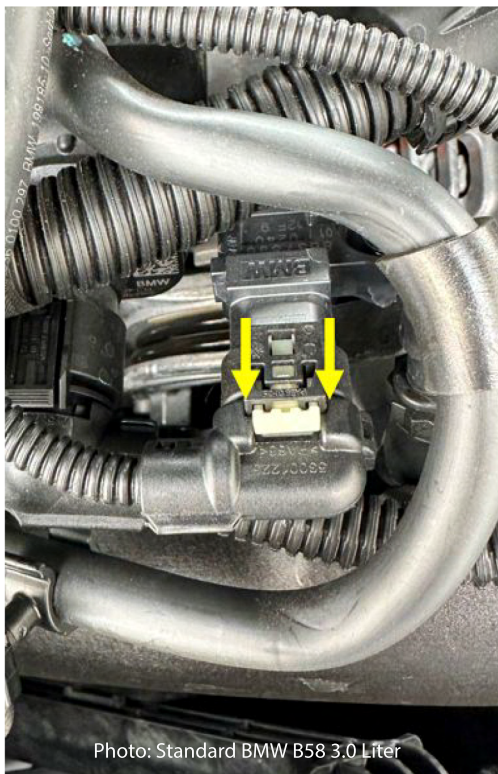

#### 1. open the plug connection:

To open the plug connection, move the gray lock of the plug connector in the direction of the arrows. Then press the open lock downwards until the plug connection can be released.

#### 2. connect channel B:

Connect the connection channel B of the supplied cable between the sensor and the connector of the vehicle. Ensure that the connection engages firmly and securely in the correct orientation.

#### 3. lock the locking mechanism:

Then re-lock the gray locking pins of the connectors to ensure that the connection is stable and secure. Ensure that all connections are correctly and firmly connected to ensure safe operation.



## Connection Channel C – Camshaft Sensor

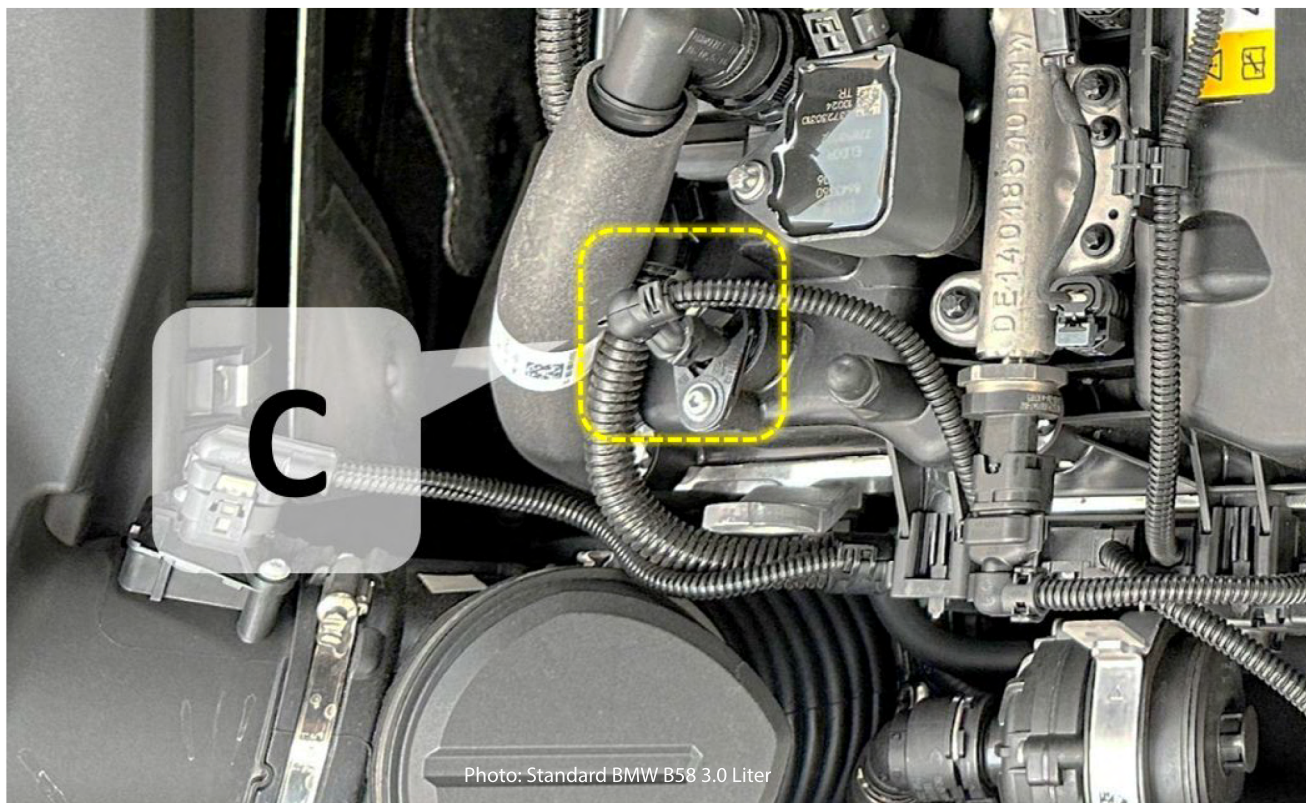

### Connecting the plug connection C



#### 1. open the locking mechanism:

To open the plug connection, move the gray lock of the plug connector in the direction of the arrows. Then press the open lock downwards until the plug connection can be released.

#### 2. install connection channel C:

Connect the connection channel C of the supplied cable between the sensor and the connector of the vehicle. Ensure that the connection engages firmly and securely in the correct orientation.

#### 3. secure the locking mechanism:

Then lock the gray locking pins of the connectors again to ensure that the connection is stable and secure.

## Completing the Installation

### 1. Connect the IOBOX Module:

The connection of the cable adapter is now complete. Connect the IOBOX module to the compact connector of the cable adapter.

### 2. Position the Module:

Position the IOBOX module in a splash-proof location in the engine compartment. Ensure that the module is not installed near hot or moving parts.

### 3. Secure the Cable and Module:

Use additional cable ties to securely fasten the cable adapter and the IOBOX module. Ensure that the cable is firmly and securely routed to prevent chafing or damage.

### 4. Finally, put the motor cover back in place.

The installation of the IOBOX Performance Tuning is now complete. Finally, check all connections and fastenings before reinstalling the engine cover and starting the vehicle.

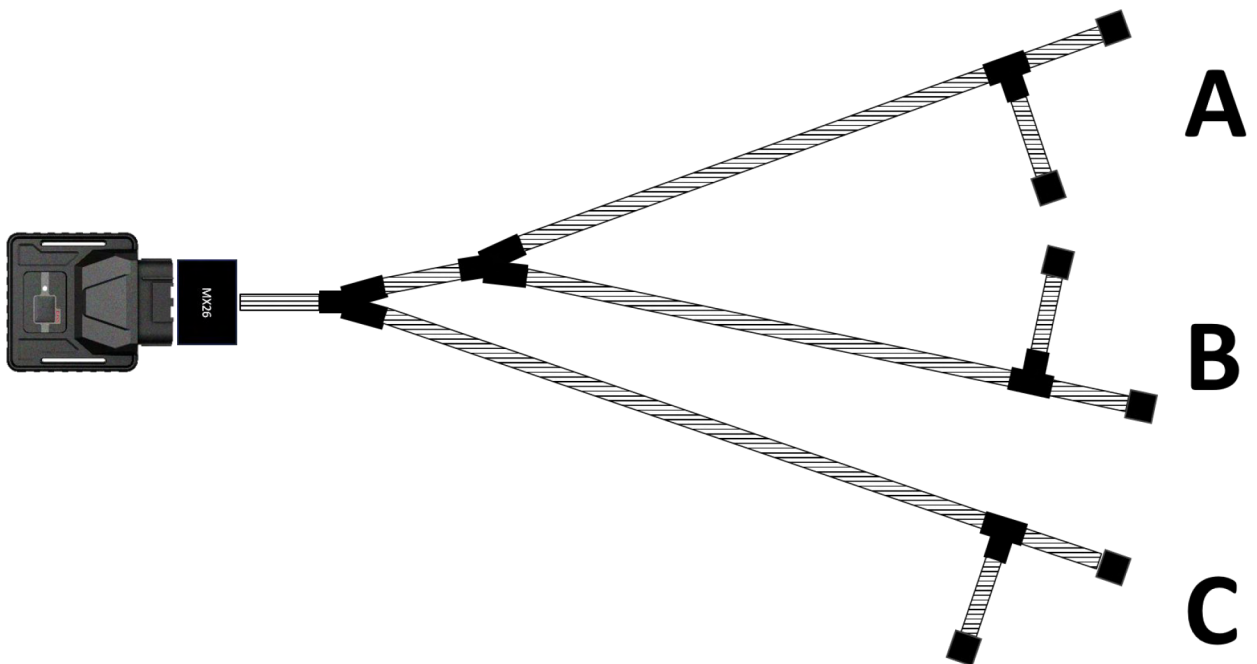



## Support-Contact Information

The IOTuning Support Team is available during office hours to assist you.



**Quick Help or Answering Your Questions via WhatsApp:**  
WhatsApp: [+49 163 253 5541](https://wa.me/491632535541)



**Email Support:**  
Email: [support@iotuning.com](mailto:support@iotuning.com)



**Phone Support:**  
You can also reach us by phone at:  
Phone: +49 (0)231 5867 7250

**For quick and efficient support, please include the following information in your first contact:**

- Name, Email, Phone Number
- Sales Invoice (PDF/Image)
- Vehicle Make, Model, Engine, and Year
- Serial Numbers of the Devices
- Pictures of Connectors, if applicable
- Problem Description

We look forward to assisting you!

# Imprint

## **IOTuning GmbH**

Am Alten Ostbahnhof 38

44135 Dortmund

Germany

## **Managing Director:**

Andre Henkel

## **Tax Number:**

317/5913/3475

## **Commercial Register:**

Registered in Dortmund, HRB No.: 33020

## **Tax Identification Number/VAT:**

DE343919967

## **WEEE Registration Number:**

DE 71202783

# Wire Harness Routing

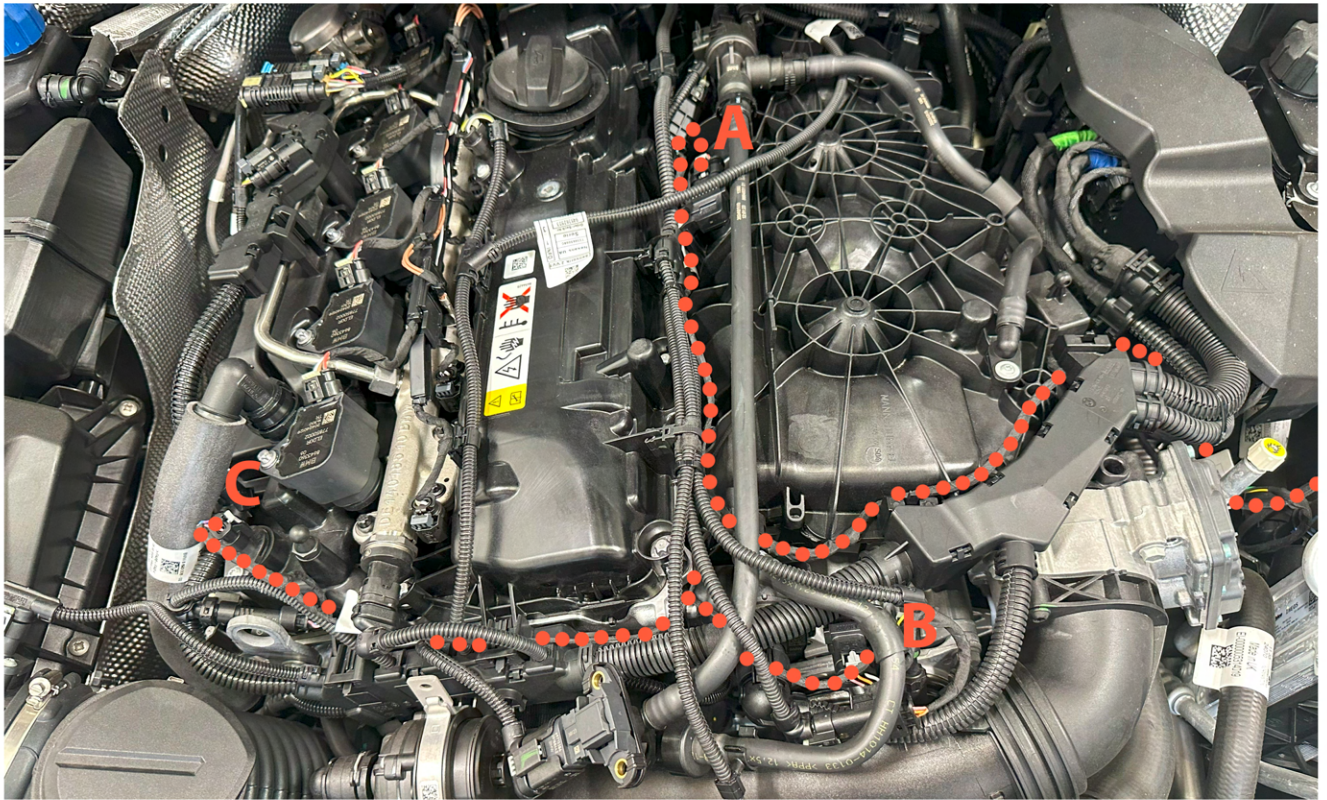

Follow the above wire harness routing layout for optima routing of harness to module. Use the supplied wire ties where possible to secure harness.



Install the supplied module bracket using the factory fender bolts with the supplied 1/4" spacers between bracket and fender. Attach the module to the bracket using the supplied 2" velcro pad and 2 wire ties.

**\*\* Write down passkey code located on the back side of module before installation\*\***

